

## TRIODE—PENTODE

### DESCRIPTION AND RATING

The 6AU8-A is a general-purpose miniature tube which contains a sharp-cut-off pentode and a medium-mu triode in one envelope. Each section has a separate cathode and is electrically independent.

The tube is suitable for a wide variety of general-purpose applications in both monochrome and color television receivers. The high figure of merit of the pentode section makes it particularly suited for service as a video amplifier, video intermediate-frequency amplifier, and sound intermediate-frequency amplifier. The triode section is intended for use as a sync amplifier, separator, or clipper, or as a sweep oscillator. The triode section may also be connected as a diode for video-detector applications, which adds to the over-all versatility of the tube.

In addition, the 6AU8-A, as a result of its controlled heater warm-up characteristic, is especially suited for use in television receivers that employ series-connected heaters. The 6AU8-A differs from the 6AU8 primarily by incorporating a controlled plate-knee characteristic.

#### ELECTRICAL

Cathode—Coated Unipotential  
 Heater Voltage, AC or DC.....6.3 Volts  
 Heater Current.....0.6 Amperes  
 Heater Warm-up Time\*.....11 Seconds  
 Direct Interelectrode Capacitances†

#### GENERAL

##### Pentode Section

Grid-Number 1 to Plate.....0.06  $\mu\text{f}$   
 Input.....7.5  $\mu\text{f}$   
 Output.....3.4  $\mu\text{f}$

##### Triode Section

Grid to Plate.....2.2  $\mu\text{f}$   
 Input.....2.6  $\mu\text{f}$   
 Output.....0.34  $\mu\text{f}$

Pentode Grid-Number 1 to Triode Plate, maximum.....0.006  $\mu\text{f}$

Triode Grid to Pentode Plate, maximum.....0.022  $\mu\text{f}$

Pentode Plate to Triode Plate, maximum.....0.12  $\mu\text{f}$

#### MECHANICAL

Mounting Position—Any  
 Envelope—T-6½, Glass  
 Base—E9-1, Small Button 9-Pin

#### MAXIMUM RATINGS

DESIGN-CENTER VALUES	Pentode Section	Triode Section	
Plate Voltage.....	300	300	Volts
Screen-Supply Voltage.....	300	....	Volts
Screen Voltage—See Screen Rating Chart			
Positive DC Grid-Number 1 Voltage.....	0	0	Volts
Plate Dissipation.....	3.0	2.5	Watts
Screen Dissipation.....	1.0	....	Watts
Heater-Cathode Voltage			
Heater Positive with Respect to Cathode			
DC Component.....	100	100	Volts
Total DC and Peak.....	200	200	Volts
Heater Negative with Respect to Cathode			
Total DC and Peak.....	200	200	Volts
Grid-Number 1 Circuit Resistance			
With Fixed Bias.....	0.25	0.5	Megohms
With Cathode Bias.....	1.0	1.0	Megohms

#### BASING DIAGRAM

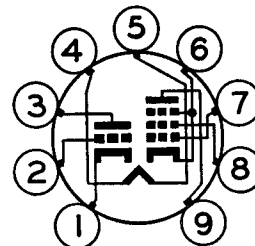

EIA 9DX

#### TERMINAL CONNECTIONS

- Pin 1—Triode Cathode
- Pin 2—Triode Grid
- Pin 3—Triode Plate
- Pin 4—Heater
- Pin 5—Heater
- Pin 6—Pentode Cathode, Grid Number 3, and Internal Shield
- Pin 7—Pentode Grid Number 1
- Pin 8—Pentode Grid Number 2 (Screen)
- Pin 9—Pentode Plate

#### PHYSICAL DIMENSIONS

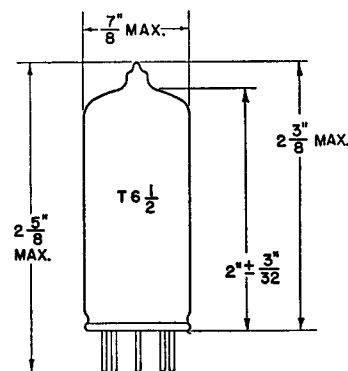

EIA 6-3

## CHARACTERISTICS AND TYPICAL OPERATION

AVERAGE CHARACTERISTICS	Pentode Section	Triode Section	
Plate Voltage .....	200	40	150
Screen Voltage .....	125	125	.....
Grid Voltage .....	.....	0	.....
Cathode-Bias Resistor .....	82	.....	150
Amplification Factor .....	.....	.....	43
Plate Resistance, approximate .....	100,000	.....	8100
Transconductance .....	8000	.....	5300
Plate Current .....	17	30	9.5
Screen Current .....	3.4	10.6	.....
Grid-Number 1 Voltage, approximate I <sub>b</sub> = 100 Microamperes .....	-7.5	.....	-6.5
			Volts
			Volts
			Ohms
			Ohms
			Micromhos
			Milliamperes
			Milliamperes

\* The time required for the voltage across the heater to reach 80 percent of its rated value after applying 4 times rated heater voltage to a circuit consisting of the tube heater in series with a resistance equal to 3 times the rated heater voltage divided by the rated heater current.

† Without external shield.

Note: The triode section of the 6AU8-A may be diode-connected and employed as a high-perveance diode in video detector applications. The diode operation can be obtained either with the triode grid connected to the triode plate and the combination operated as the plate of the diode, or with the triode plate grounded and the triode grid operated as the plate of the diode.

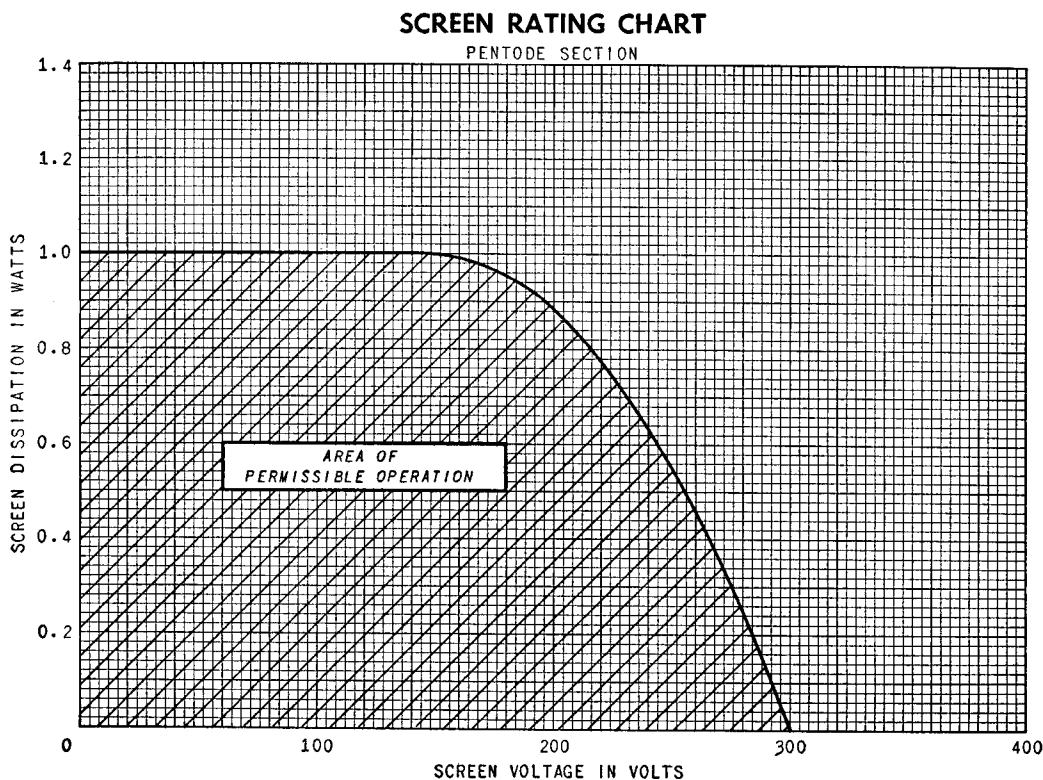

The tubes and arrangements disclosed herein may be covered by patents of General Electric Company or others. Neither the disclosure of any information herein nor the sale of tubes by General Electric Company conveys any license under patent claims covering combinations of tubes with other devices or elements. In the absence of an express written agreement to the contrary, General Electric Company assumes no liability for patent infringement arising out of any use of the tubes with other devices or elements by any purchaser of tubes or others.

**AVERAGE PLATE CHARACTERISTICS**

PENTODE SECTION

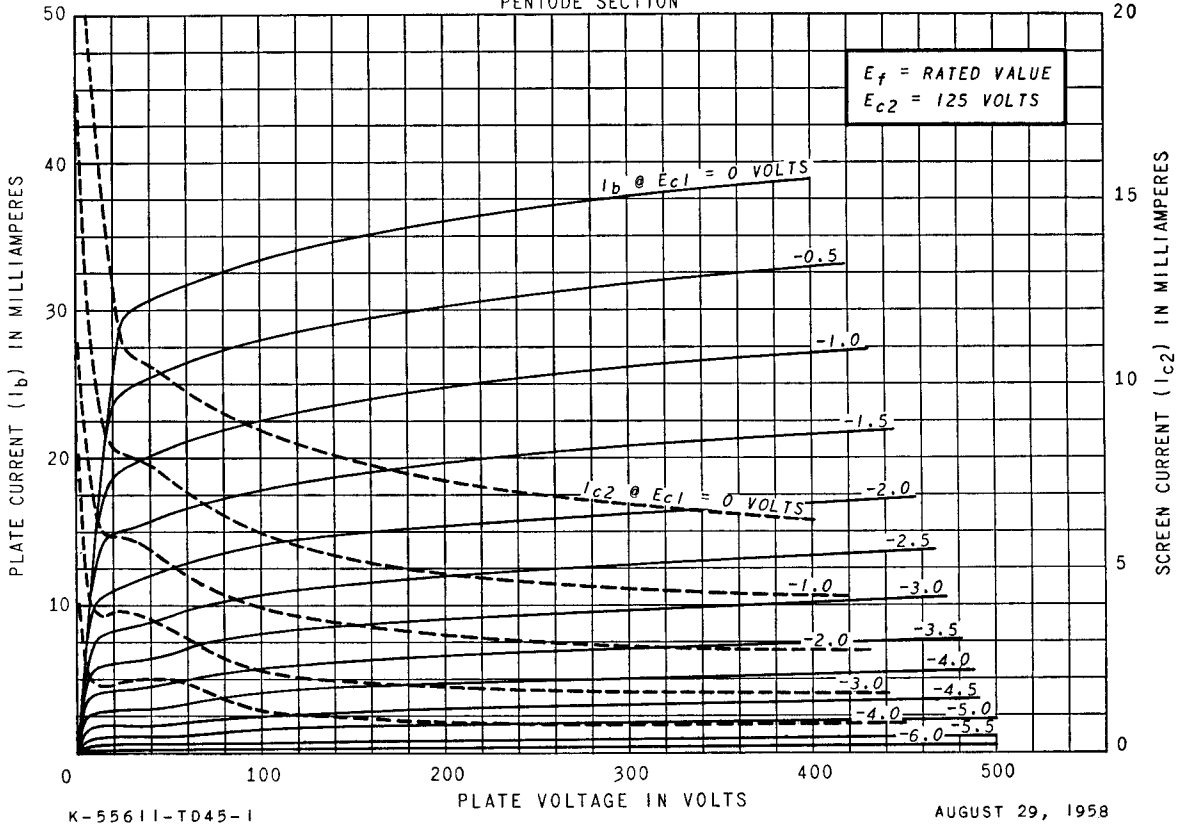

**AVERAGE PLATE CHARACTERISTICS**

PENTODE SECTION

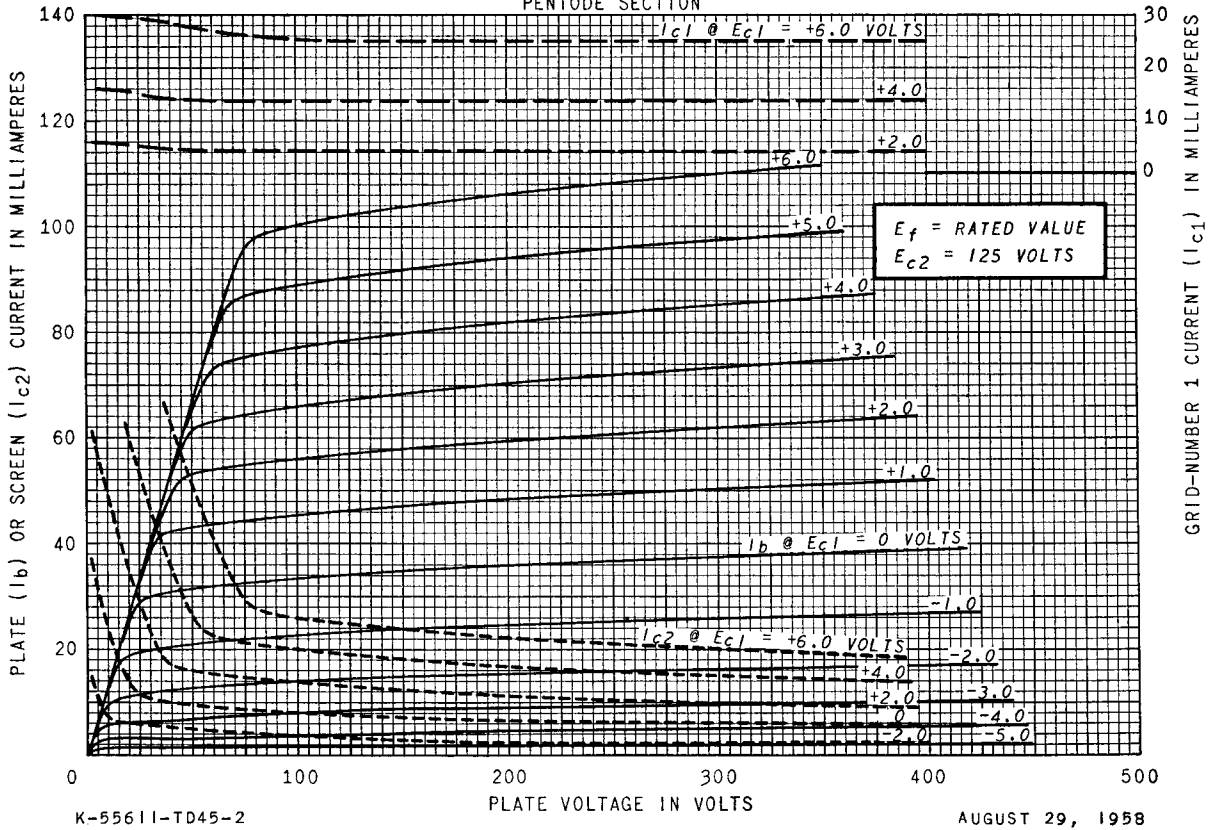

**AVERAGE PLATE CHARACTERISTICS**

PENTODE SECTION

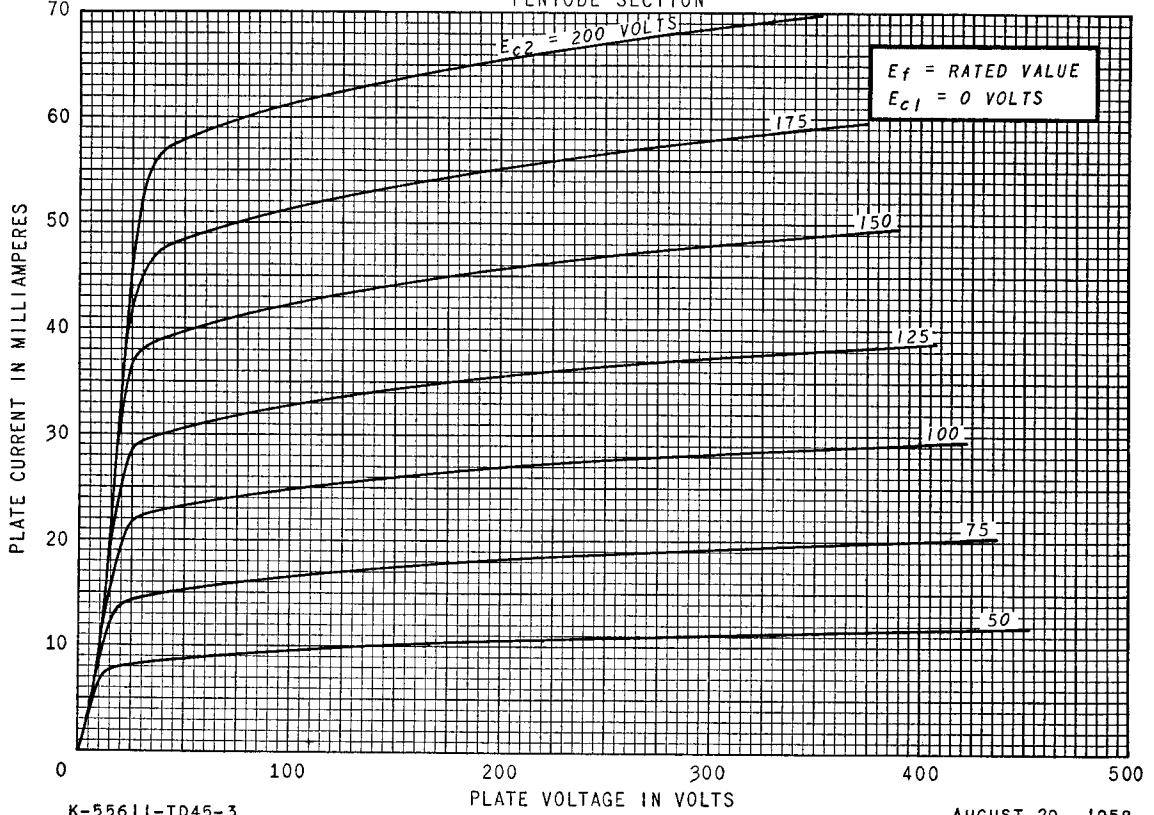

K-55611-TD45-3

AUGUST 29, 1958

**AVERAGE TRANSFER CHARACTERISTICS**

PENTODE SECTION

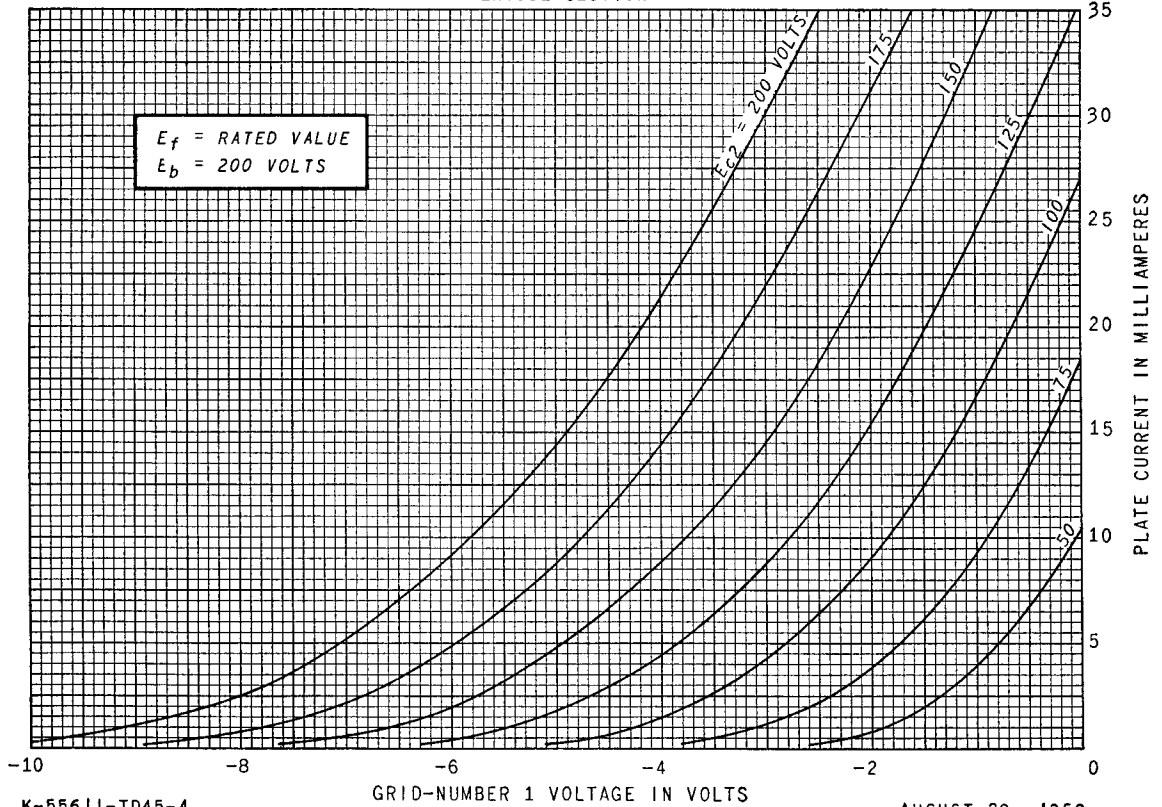

K-55611-TD45-4

AUGUST 29, 1958

**AVERAGE TRANSFER CHARACTERISTICS**

PENTODE SECTION

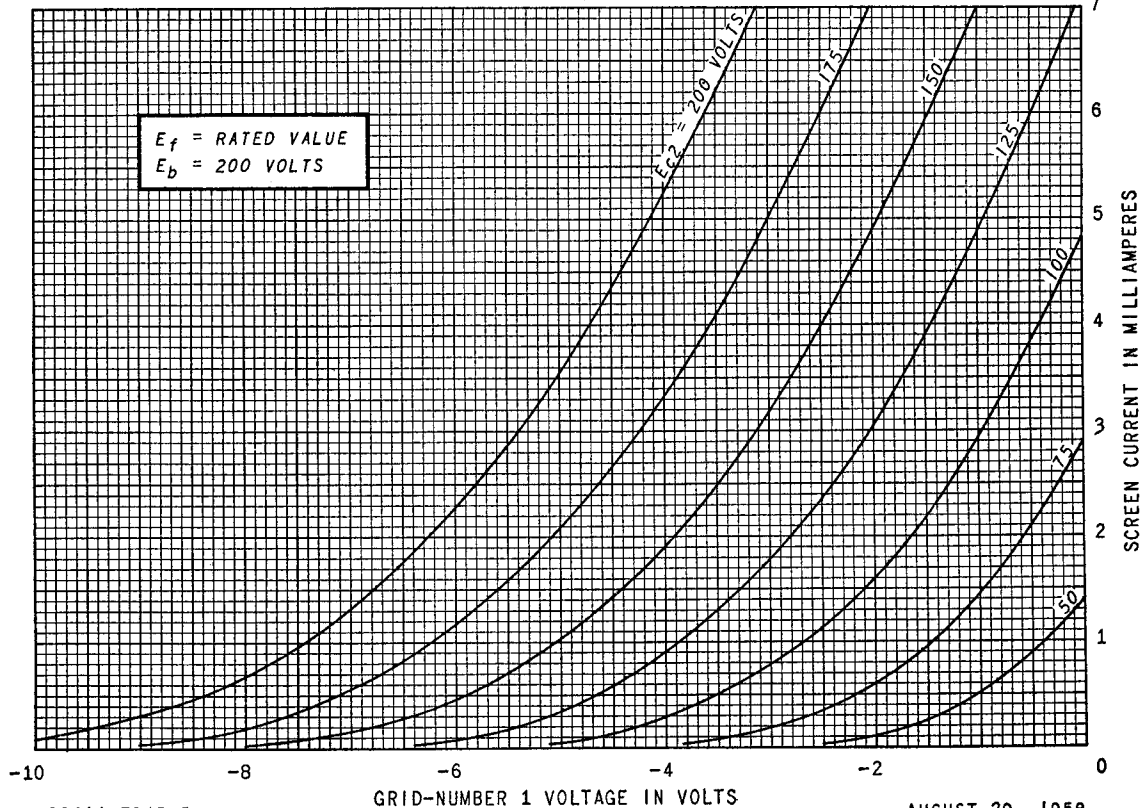

**AVERAGE TRANSFER CHARACTERISTICS**

PENTODE SECTION

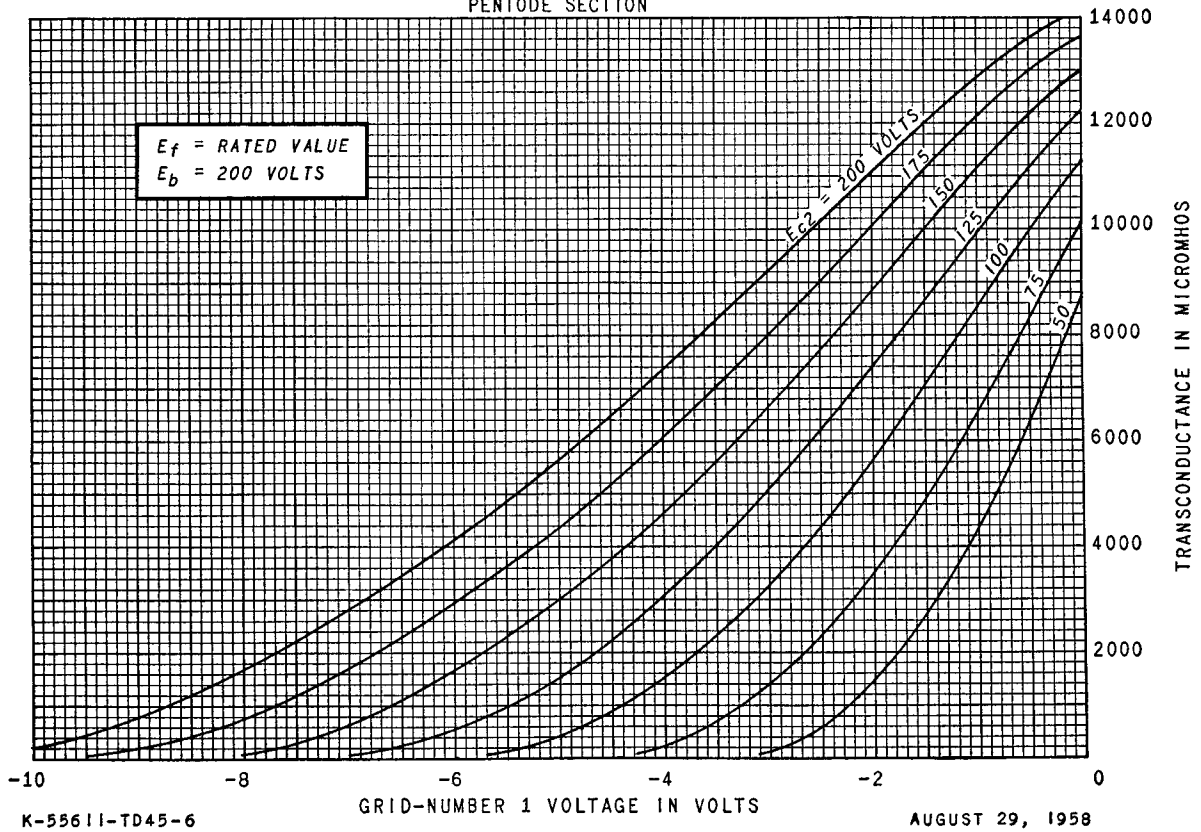

**AVERAGE PLATE CHARACTERISTICS**

TRIODE SECTION

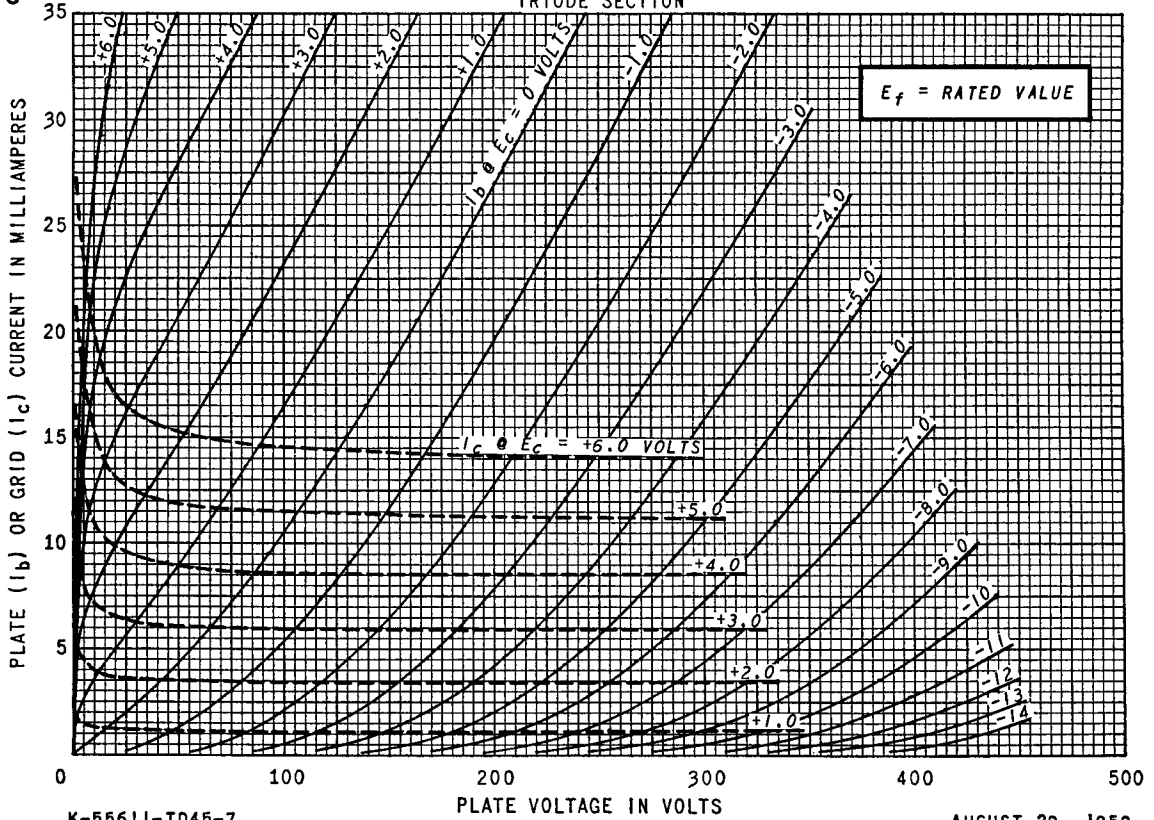

K-55611-TD45-7

AUGUST 29, 1958

**AVERAGE TRANSFER CHARACTERISTICS**

TRIODE SECTION

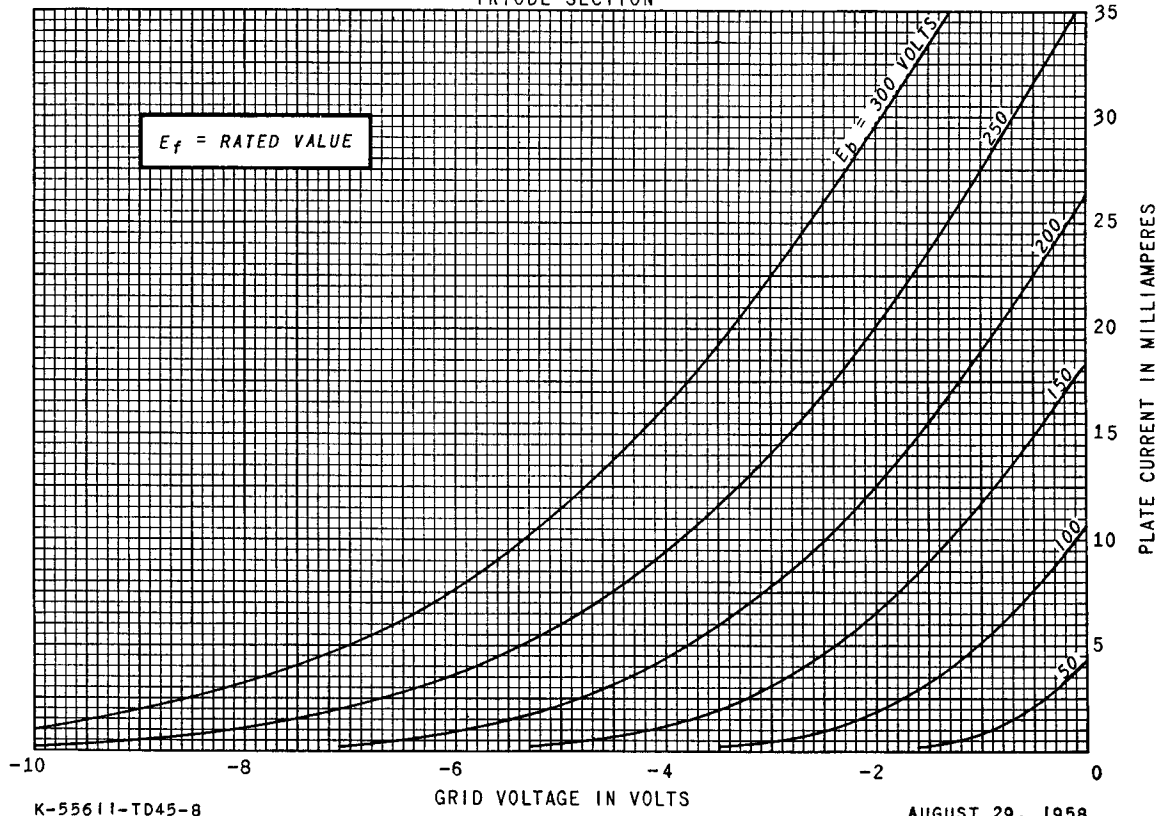

K-55611-TD45-8

AUGUST 29, 1958

**AVERAGE CHARACTERISTICS**

TRIODE SECTION

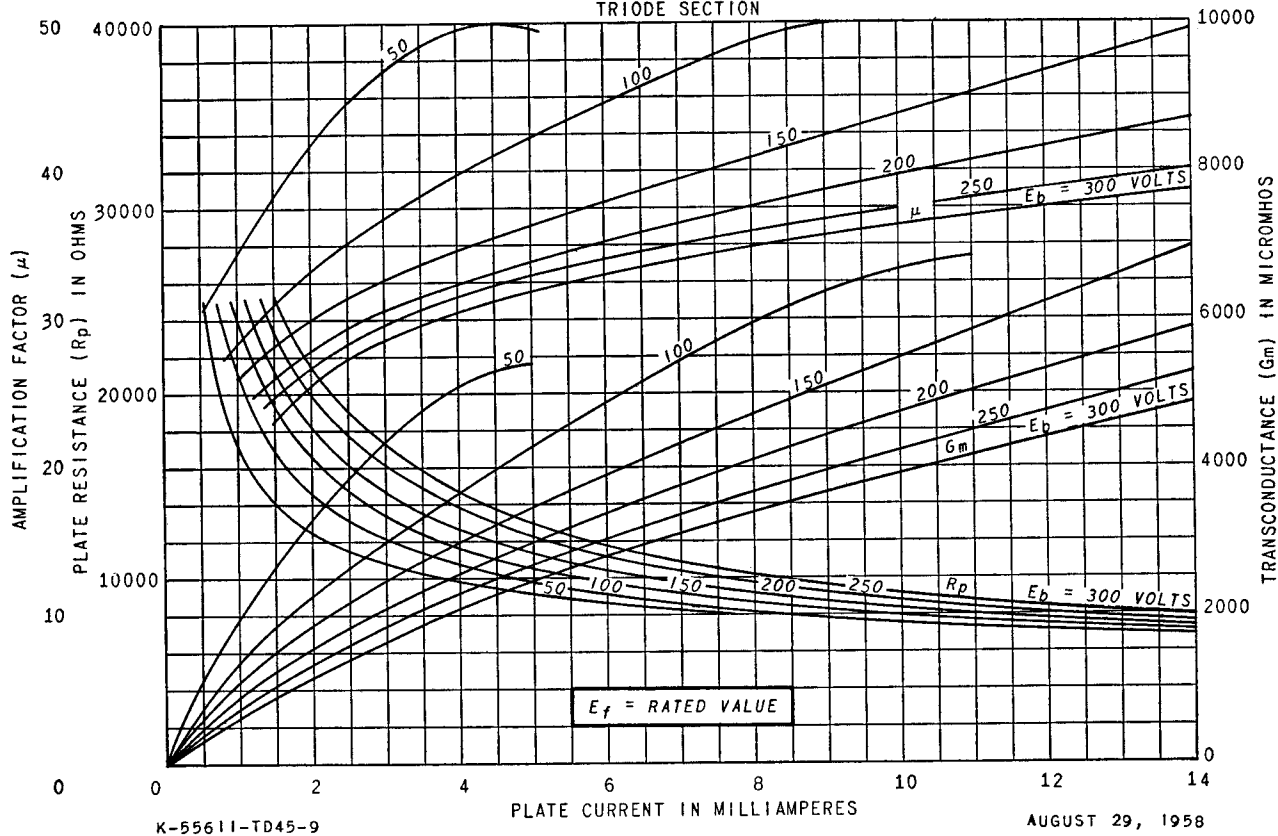

K-55611-TD45-9

AUGUST 29, 1958